

| 構成内容 / Components |  |              |  |                               |
|-------------------|--|--------------|--|-------------------------------|
| No.               | 名称 / Part name                                   | 数量 / Pcs     | 材質 / Material                                    | 色・表面処理 / Color・Finish         |
| 1                 | 上下カバー<br>Top and Bottom cover                    | 各1<br>1 each | アクリル板 t3.0<br>Acrylic t3.0                       | 透明<br>Transparent             |
| 2                 | Wパネル<br>W panel                                  | 2            | アクリル板 t3.0<br>Acrylic t3.0                       | 透明<br>Transparent             |
| 3                 | Dパネル<br>D panel                                  | 2            | アクリル板 t3.0<br>Acrylic t3.0                       | 透明<br>Transparent             |
| 4                 | 支柱<br>Extruded pillar                            | 4            | アルミ押出材 A6063S-T5<br>Extruded aluminium A6063S-T5 | シルバー・アルマイト<br>Silver・Anodized |
| 5                 | 取付ビス (六角穴付皿M4 x 10)<br>Screw (Hexagonal M4 - 10) | 8            | ステンレス<br>Stainless steel                         | 無処理<br>Unfinished             |
| 6                 | ゴム足 / Rubber feet                                | 0 or 5       | ポリウレタン / Polyurethane                            | 透明 / Transparent              |

■六角レンチ付です。  
Hexagonal wrench included.

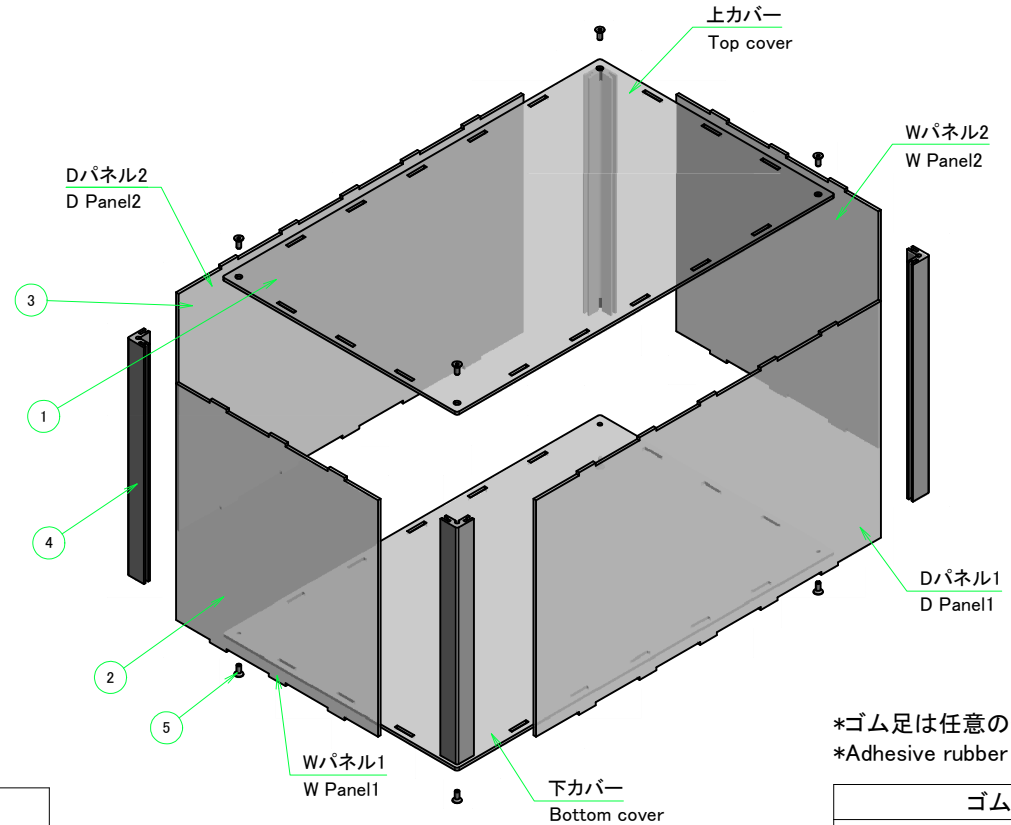

ケース型番 / Product Number

SKSF  -  -  K20   
 W H D タイプ ゴム足  
 Type Rubber feet

| W・H・D 寸法制限範囲 / Dimension limit range |          |           |
|--------------------------------------|----------|-----------|
| W                                    | H        | D         |
| 201 ~ 250                            | 30 ~ 500 | 401 ~ 500 |

\*ゴム足は任意の位置に貼り付けできます。  
\*Adhesive rubber feet in cluded

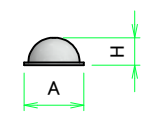

| ゴム足 / Rubber feet |      |     |
|-------------------|------|-----|
| 記号 / Code         | A    | H   |
| N (無し) / None     | -    | -   |
| S                 | 11.2 | 5.1 |
| L                 | 15.7 | 7.9 |

|  |                  |                  |   |                   |
|--|------------------|------------------|---|-------------------|
| 株式会社タカチ電機工業<br>TAKACHI ELECTRONICS ENCLOSURE CO., LTD. |                  |                  | 品名/Title<br>角型スケルトンフリーサイズケース<br>CUSTOM SIZED ACRYLIC CASE | 尺度/Scale<br>1 / 5 |
| 承認/Approved<br>中根                                      | 検図/Checked<br>常山 | 製図/Created<br>野村 | 型番/Product number<br>SKSF□-□-□K20□ (W201~250, D401~500)   |                   |
|  |                  |                  | 作成日/Date<br>2020/12/10                                    |                   |

外視 / External View

Wパネル2 / W Panel 2

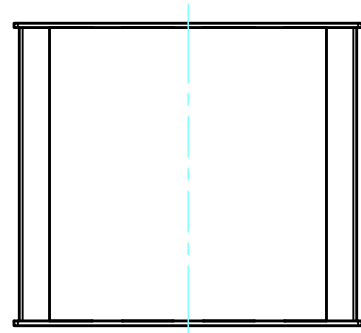

Dパネル2 / D Panel 2

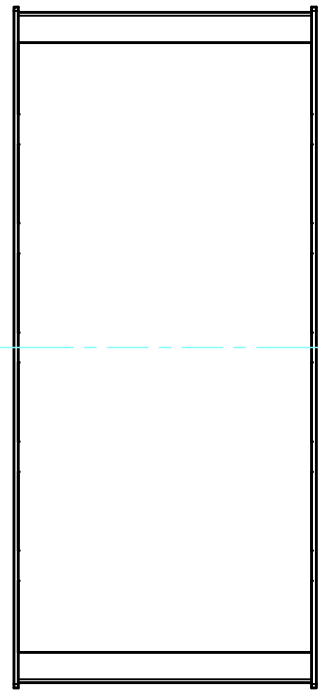

上カバー / Top cover

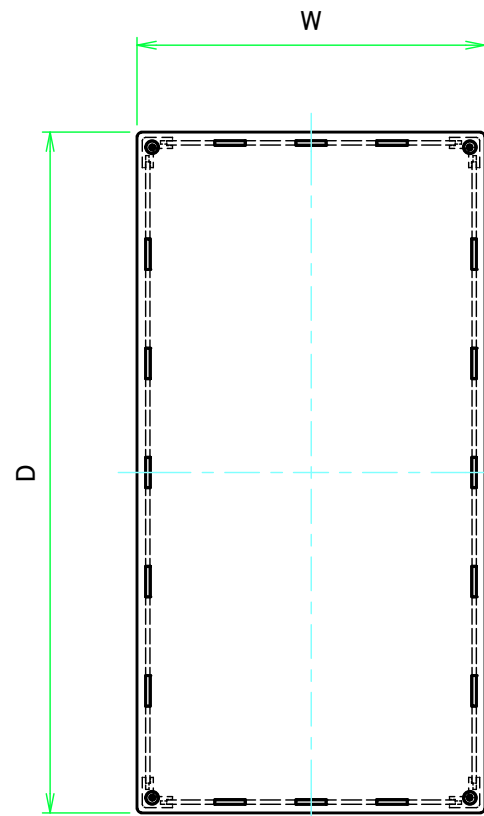

Dパネル1 / D Panel 1

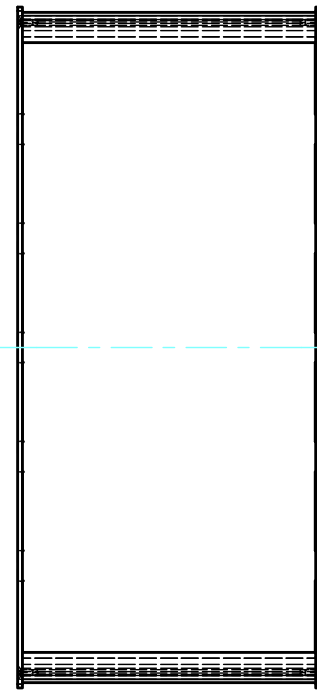

下カバー / Bottom cover

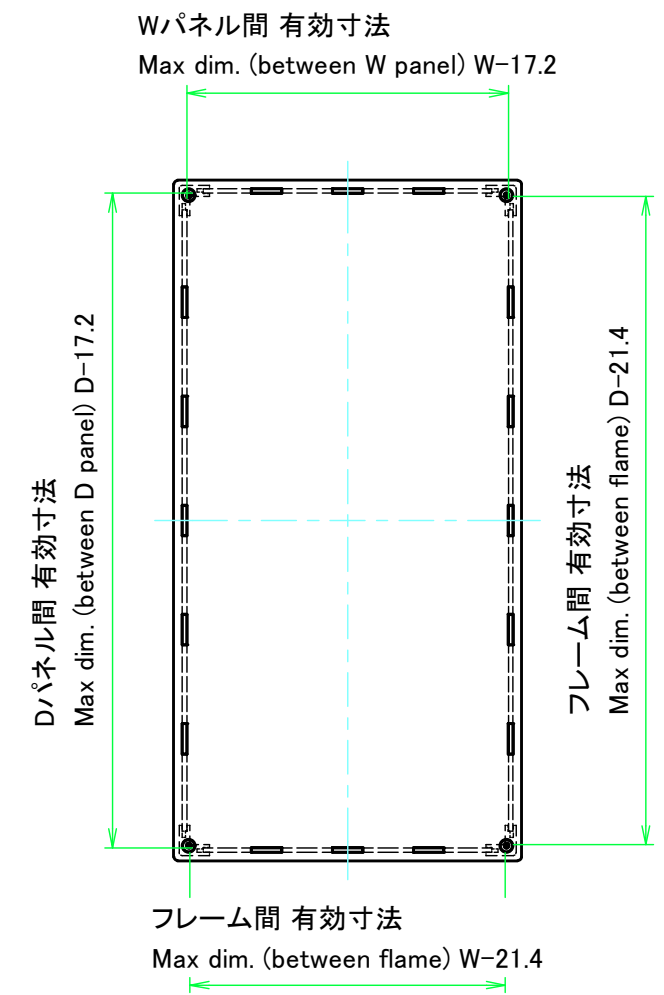

Wパネル1 / W Panel 1

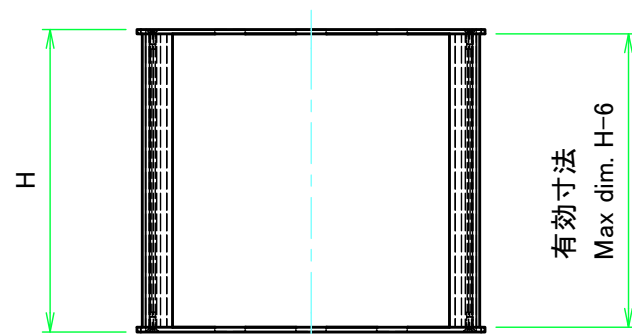

|  |            |            |   |                 |
|--|------------|------------|---|-----------------|
| 株式会社タカチ電機工業<br>TAKACHI ELECTRONICS ENCLOSURE CO., LTD. |            |            | 品名/Title<br>角型スケルトンフリーサイズケース<br>CUSTOM SIZED ACRYLIC CASE | 尺度/Scale<br>1:5 |
| 承認/Approved  | 検図/Checked | 製図/Created | 型番/Product number<br>SKSF□-□-□K20□ (W201~250, D401~500)   |                 |
| 中根   | 常山         | 野村         | 作成日/Date<br>2020/12/10                                    | 2 / 5           |

上下カバー / Top and Bottom cover

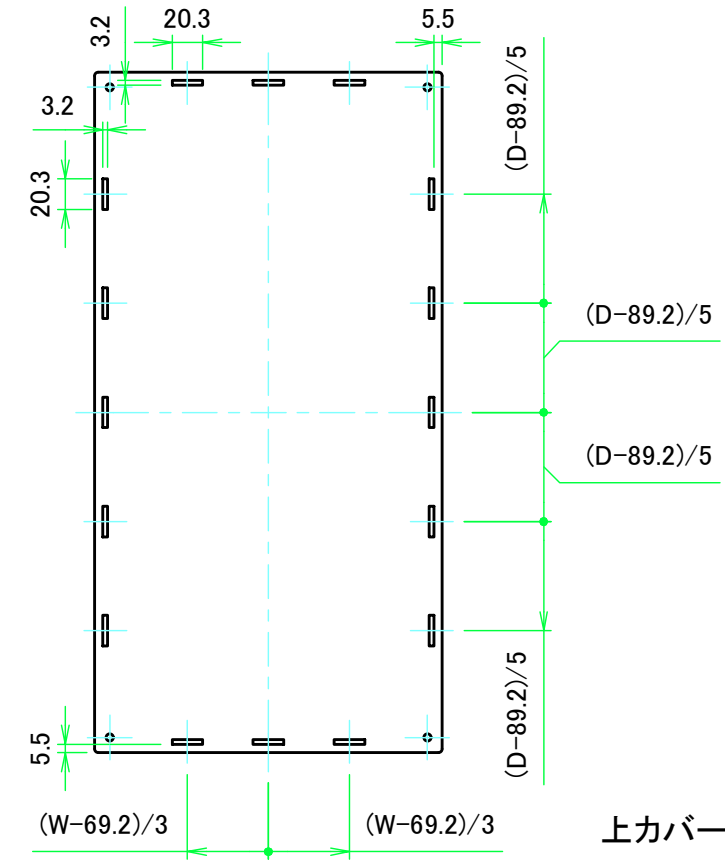
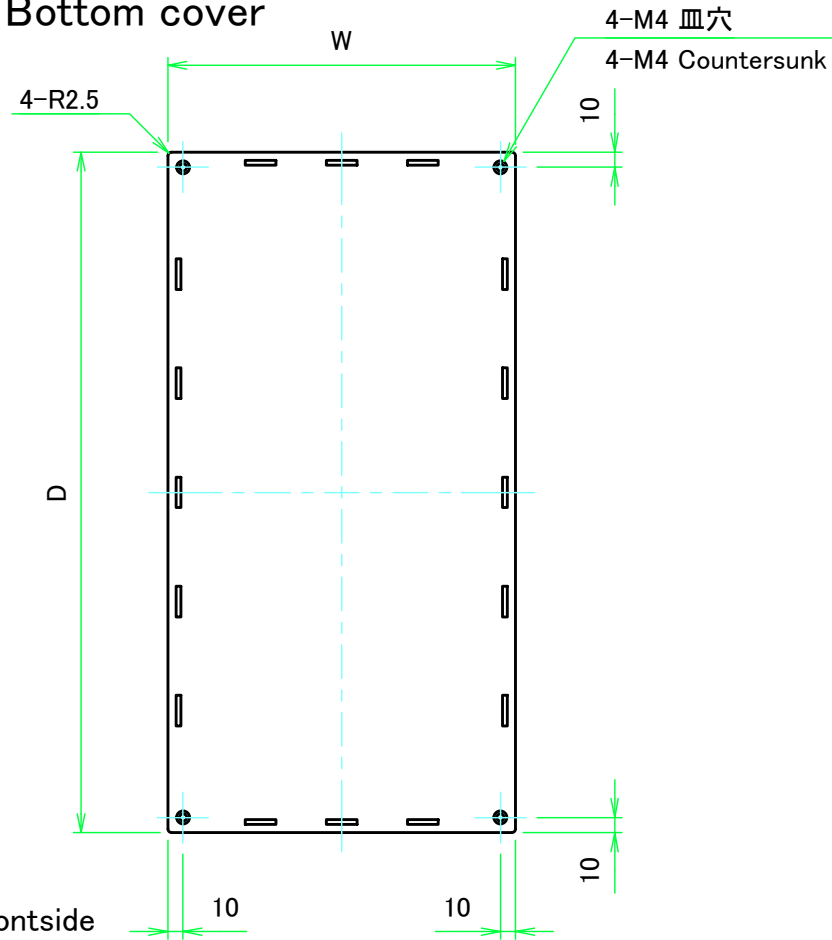

上カバー裏面 / Top cover Backside

上カバー表面 / Top cover Frontside

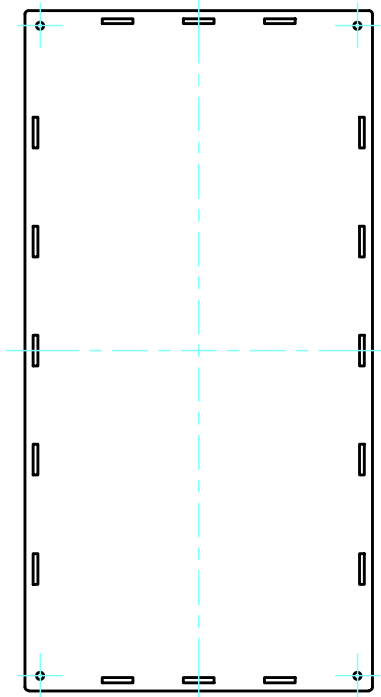
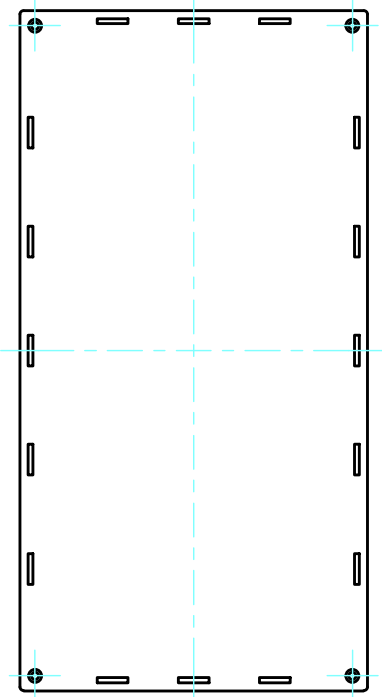

下カバー裏面 / Bottom cover Backside

下カバー表面 / Bottom cover Frontside

|  |            |            |   |                 |
|--|------------|------------|---|-----------------|
| 株式会社タカチ電機工業<br>TAKACHI ELECTRONICS ENCLOSURE CO., LTD. |            |            | 品名/Title<br>角型スケルトンフリーサイズケース<br>CUSTOM SIZED ACRYLIC CASE | 尺度/Scale<br>1:5 |
| 承認/Approved  | 検図/Checked | 製図/Created | 型番/Product number<br>SKSF□-□-□K20□ (W201~250, D401~500)   |                 |
| 中根   | 常山         | 野村         | 作成日/Date<br>2020/12/10                                    | 3 / 5           |

# Wパネル / W Panel

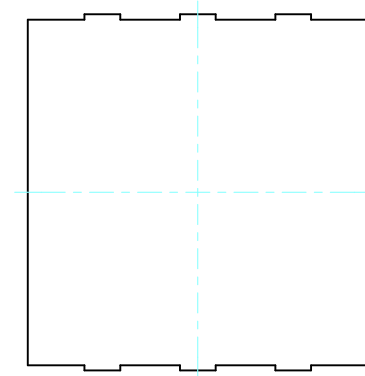
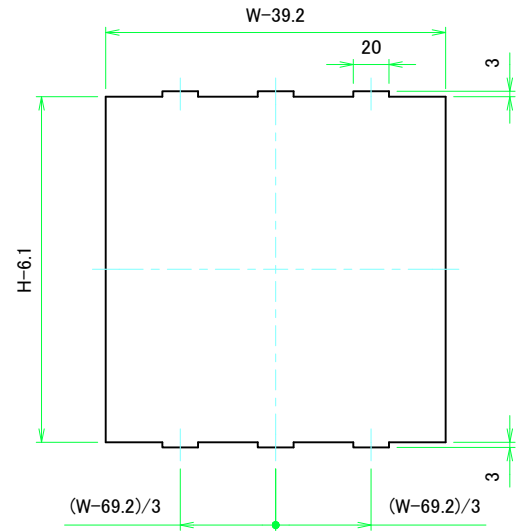

Wパネル1表面 / W Panel 1 Frontside

Wパネル1裏面 / W Panel 1 Backside

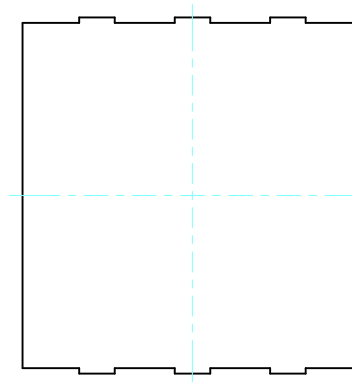
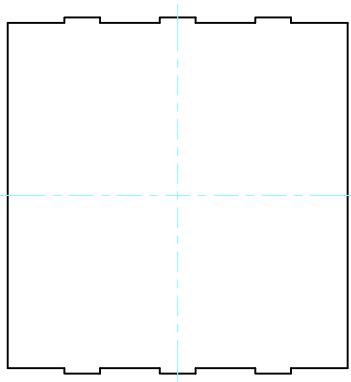

Wパネル2表面 / W Panel 2 Frontside

Wパネル2裏面 / W Panel 2 Backside

|  |                         |                         |  |                 |
|--|-------------------------|-------------------------|--|-----------------|
| <b>株式会社タカチ電機工業</b><br><small>TAKACHI ELECTRONICS ENCLOSURE CO., LTD.</small> |                         |                         | <b>品名/Title</b><br>角型スケルトンフリーサイズケース<br>CUSTOM SIZED ACRYLIC CASE | 尺度/Scale<br>1:3 |
| <b>承認/Approved</b><br>中根   | <b>検図/Checked</b><br>常山 | <b>製図/Created</b><br>野村 | <b>型番/Product number</b><br>SKSF□-□-□K20□ (W201~250, D401~500)   |                 |
|  |                         |                         | <b>作成日/Date</b> 2020/12/10                                       | 4 / 5           |

# Dパネル / D Panel

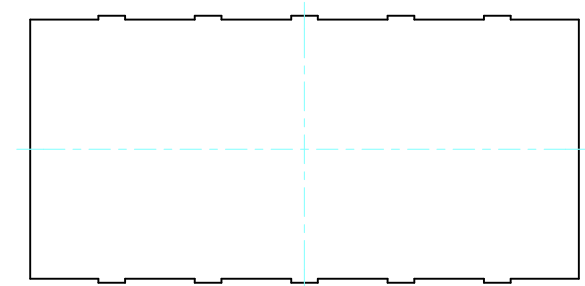
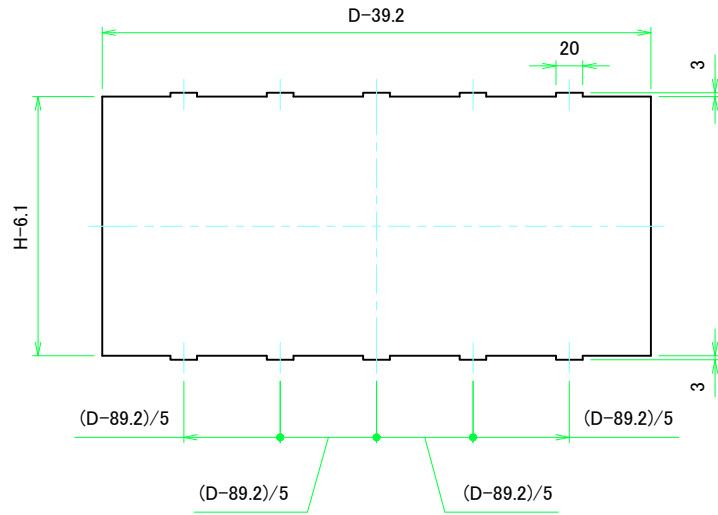

Dパネル1表面 / D Panel 1 Frontside

Dパネル1裏面 / D Panel 1 Backside

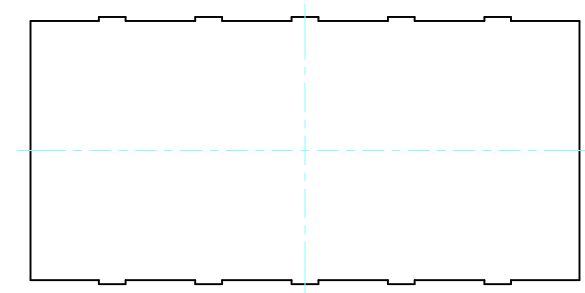
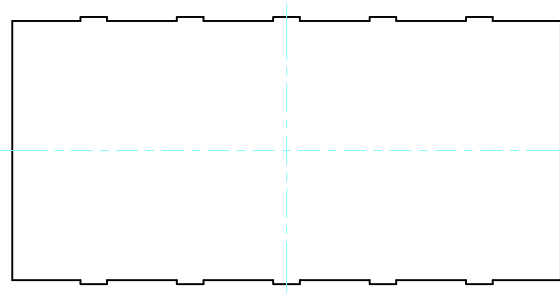

Dパネル2表面 / D Panel 2 Frontside

Dパネル2裏面 / D Panel 2 Backside

|  |                         |                         |  |                 |
|--|-------------------------|-------------------------|--|-----------------|
| <b>株式会社タカチ電機工業</b><br><small>TAKACHI ELECTRONICS ENCLOSURE CO., LTD.</small> |                         |                         | <b>品名/Title</b><br>角型スケルトンフリーサイズケース<br>CUSTOM SIZED ACRYLIC CASE | 尺度/Scale<br>1:4 |
| <b>承認/Approved</b><br>中根   | <b>検図/Checked</b><br>常山 | <b>製図/Created</b><br>野村 | <b>型番/Product number</b><br>SKSF□-□-□K20□ (W201~250, D401~500)   |                 |
|  |                         |                         | <b>作成日/Date</b> 2020/12/10                                       | 5 / 5           |